



Standard Practice for Structural Design of Corrugated Steel Pipe, Pipe-Arches, and Arches for Storm and Sanitary Sewers and Other Buried Applications¹

This standard is issued under the fixed designation A 796/A 796M; the number immediately following the designation indicates the year of original adoption or, in the case of revision, the year of last revision. A number in parentheses indicates the year of last reappraisal. A superscript epsilon (ε) indicates an editorial change since the last revision or reappraisal.

1. Scope*

1.1 This practice covers the structural design of corrugated steel pipe and pipe-arches, ribbed and composite ribbed steel pipe, ribbed pipe with metallic-coated inserts, closed rib steel pipe, composite corrugated steel pipe, and steel structural plate pipe, pipe-arches, and underpasses for use as storm sewers and sanitary sewers, and other buried applications. Ribbed and composite ribbed steel pipe, ribbed pipe with metallic-coated inserts, closed rib steel pipe, and composite corrugated steel pipe shall be of helical fabrication having a continuous lockseam. This practice is for pipe installed in a trench or embankment and subjected to earth loads and live loads. It must be recognized that a buried corrugated steel pipe is a composite structure made up of the steel ring and the soil envelope, and both elements play a vital part in the structural design of this type of structure. This practice applies to structures installed in accordance with Practice A 798/A 798M or A 807/A 807M.

1.2 Corrugated steel pipe and pipe-arches shall be of annular fabrication using riveted or spot-welded seams, or of helical fabrication having a continuous lockseam or welded seam.

1.3 Structural plate pipe, pipe-arches, underpasses, and arches are fabricated in separate plates that, when assembled at the job site by bolting, form the required shape.

1.4 This specification is applicable to design in inch-pound units as A 796 or in SI units as A 796M. Inch-pound units and SI units are not necessarily equivalent. SI units are shown in brackets in the text for clarity, but they are the applicable values when the design is done per A 796M.

1.5 *This standard does not purport to address all of the safety concerns, if any, associated with its use. It is the responsibility of the user of this standard to establish appropriate safety and health practices and determine the applicability of regulatory limitations prior to use.*

¹ This practice is under the jurisdiction of ASTM Committee A05 on Metallic-Coated Iron and Steel Products and is the direct responsibility of Subcommittee A05.17 on Corrugated Steel Pipe Specifications.

Current edition approved May 1, 2006. Published June 2006. Originally approved in 1982. Last previous edition approved in 2004 as A 796/A 796M-04a.

2. Referenced Documents

2.1 ASTM Standards:²

- A 760/A 760M Specification for Corrugated Steel Pipe, Metallic-Coated for Sewers and Drains
- A 761/A 761M Specification for Corrugated Steel Structural Plate, Zinc-Coated, for Field-Bolted Pipe, Pipe-Arches, and Arches
- A 762/A 762M Specification for Corrugated Steel Pipe, Polymer Precoated for Sewers and Drains
- A 798/A 798M Practice for Installing Factory-Made Corrugated Steel Pipe for Sewers and Other Applications
- A 807/A 807M Practice for Installing Corrugated Steel Structural Plate Pipe for Sewers and Other Applications
- A 902 Terminology Relating to Metallic-Coated Steel Products
- A 978/A 978M Specification for Composite Ribbed Steel Pipe, Precoated and Polyethylene-Lined for Gravity Flow Sanitary Sewers, Storm Sewers, and Other Special Applications
- A 1019/A 1019M Specification for Closed Rib Steel Pipe with a Diameter of 36 in. [900 mm] or Less, Polymer Precoated for Sewers and Drains
- A 1042/A 1042M Specification for Composite Corrugated Steel Pipe for Sewer and Drains
- D 698 Test Method for Laboratory Compaction Characteristics of Soil Using Standard Effort (12 400 ft-lbf/ft³ [600 kN·m/m³])
- D 1556 Test Method for Density and Unit Weight of Soil in Place by the Sand-Cone Method
- D 2167 Test Method for Density and Unit Weight of Soil in Place by the Rubber Balloon Method
- D 2487 Classification of Soils for Engineering Purposes (Unified Soil Classification System)
- D 2922 Test Methods for Density of Soil and Soil-Aggregate in Place by Nuclear Methods (Shallow Depth)

² For referenced ASTM standards, visit the ASTM website, www.astm.org, or contact ASTM Customer Service at service@astm.org. For *Annual Book of ASTM Standards* volume information, refer to the standard's Document Summary page on the ASTM website.

*A Summary of Changes section appears at the end of this standard.

D 2937 Test Method for Density of Soil in Place by the Drive-Cylinder Method

2.2 *AASHTO Standard:*

Standard Specifications for Highway Bridges³

2.3 *FAA Standard:*

AC No. 150/5320–5B Advisory Circular, “Airport Drainage,” Department of Transportation, Federal Aviation Administration, 1970⁴

Type 38 = 48 000 lbf/in.²[330 MPa]
 For 15 by 1½-in. [380 by 140–mm] and
 16 by 6-in. [400 by 150–mm] corrugations
 = 55 000 lbf/in.²[380 MPa]
 For all other corrugations = 45 000 lbf/
 in.²[310 MPa]

3. Terminology

3.1 *General Definitions*—For definitions of general terms used in this practice, refer to Terminology **A 902**. For definitions of terms specific to this standard, refer to **3.2**.

3.2 *Definitions of Terms Specific to This Standard:*

3.2.1 *bedding, n*—the earth or other material on which the pipe is laid, consisting of a thin layer of imported material on top of the in situ foundation.

3.2.2 *haunch, n*—the portion of the pipe cross section between the maximum horizontal dimension and the top of the bedding.

3.2.3 *invert, n*—the lowest portion of the pipe cross section; also, the bottom portion of the pipe.

3.2.4 *pipe, n*—a conduit having a full circular shape, or in a general context, all structure shapes covered by this practice.

3.2.5 *pipe-arch, n*—a pipe shape consisting of an approximate semi-circular top portion, small radius corners, and large radius invert.

3.2.6 *arch, n*—a pipe shape that is supported on footings and does not have a full metal invert.

4. Symbols

4.1 The symbols used in this practice have the following significance:

- A = required wall area, in.²/ft [mm²/mm]
- (AL) = maximum highway design axle load, lbf [N]
- C_l = longitudinal live load distribution factor for pipe arches
- d = depth of corrugation, in. [mm]
- E = modulus of elasticity = 29 by 10⁶ lbf/in.² [200 by 10³ MPa]
- (EL) = earth load, lbf/ft² [kPa]
- (FF) = flexibility factor, in./lbf [mm/N]
- f_y = specified minimum yield strength

For 6 by 2-in. [150 by 50–mm] corrugation
 Type 33 = 33 000 lbf/in.²[225 MPa]
 Type 38 = 38 000 lbf/in.²[260 MPa]

For 15 by 5½-in. [380 by 140–mm] and 16 by 6-in. [400 by 150–mm] corrugations = 44 000 lbf/in.²[300 MPa]
 For all other corrugations = 33 000 lbf/in.²[225 MPa]

f_u = specified minimum tensile strength

For 6 by 2-in. [150 by 50–mm] corrugation
 Type 33 = 45 000 lbf/in.²[310 MPa]

- f_c = critical buckling stress, lbf/in.² [MPa]
- h = height of cover, in. [mm] determined as follows: (1) highways—from top of pipe to top of rigid pavement, or to top of subgrade for flexible pavement; (2) railways—top of pipe to bottom of tie
- H = depth of fill above top of pipe, ft [m]
- H_{\min} = minimum depth of fill, ft [m]
- H_{\max} = maximum depth of fill, ft [m]
- I = moment of inertia of corrugated shape, in.⁴/in. [mm⁴/mm] (see **Tables 1-34**)
- (IL) = pressure from impact load, lbf/ft² [kPa]
- k = soil stiffness factor = 0.22 for good side-fill material compacted to 90 % of standard density based on Test Method **D 698**
- L_1, L_2, L_3 = loaded lengths, in. [mm] defined in **18.3**
- (LL) = pressure from live load, lbf/ft² [kPa]
- P = total design load or pressure, lbf/ft² [kPa]
- P_c = corner pressure, lbf/ft² [kPa]
- P_f = factored crown pressure, lbf/ft² [kPa]
- r = radius of gyration of corrugation, in. [mm] (see **Tables 1-34**)
- r_c = corner radius of pipe-arch, in. [mm]
- R_n = nominal resistance for each limit state, lbf/ft [kN/m]
- R_f = factored resistance for each limit state, lbf/ft [kN/m]
- r_l = radius at crown, in. [mm]
- S = pipe diameter or span, ft [m]
- s = pipe diameter or span, in. [mm]
- (SF) = safety factor
- (SS) = required seam strength, lbf/ft [kN/m]
- T = thrust in pipe wall, lbf/ft [kN/m]
- T_f = factored thrust in pipe wall, lbf/ft [kN/m]
- w = unit force derived from 1 ft³ [1 m³] of fill material above the pipe, lbf/ft³ [kN/m³]. When actual fill material is not known, use 120 lbf/ft³ [19 kN/m³]
- ϕ = resistance factor

5. Basis of Design

5.1 The safety factors and other specific quantitative recommendations herein represent generally accepted design practice. The design engineer should, however, determine that these recommendations meet particular project needs.

5.2 This practice is not applicable for long-span structural plate pipe or other multi-radius shapes not described herein. Such structures require additional design considerations for both the pipe and the soil envelope. In addition to meeting all other design requirements given herein, the maximum diameters or spans for structures designed by this practice are as follows:

³ Available from American Association of State Highway and Transportation Officials (AASHTO), 444 N. Capitol St., NW, Suite 249, Washington, DC 20001.

⁴ Available from Superintendent of Documents, U.S. Government Printing Office, Washington, DC 20402. Publication No. SN-050-007-00149-5.

TABLE 1 Sectional Properties of Corrugated Steel Sheets for Corrugation: 1½ by ¼ in. (Helical)

NOTE 1—Dimensions shown in the figure are exact values used in calculating the section properties. Nominal values, for some of these dimensions, are used in other places in this practice.

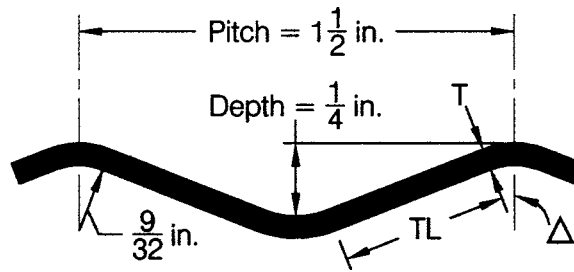

Specified Thickness, in.	Area of Section, A, in. ² /ft	Tangent Length, TL, in.	Tangent Angle, Δ, °	Moment of Inertia, I × 10 ⁻³ in. ⁴ /in.	Radius of Gyration, r, in.
0.040 ^A	0.456	0.571	21.44	0.253	0.0816
0.052	0.608	0.566	21.52	0.343	0.0824
0.064	0.761	0.560	21.61	0.439	0.0832
0.079	0.950	0.554	21.71	0.566	0.0846

^AThis thickness should only be used for the inner liner of double-wall type IA pipe, or for temporary pipe. When used for other than temporary pipe, it should be polymer coated.

TABLE 2 Sectional Properties of Corrugated Steel Sheets for Corrugation: 38 by 6.5 mm (Helical) [SI Units]

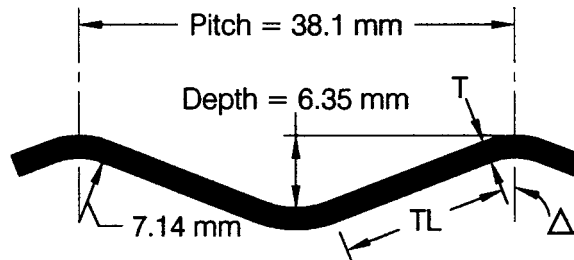

Specified Thickness, mm	Area of Section, A, mm ² /mm	Tangent Length, TL, mm	Tangent Angle, Δ, °	Moment of Inertia, I, mm ⁴ /mm	Radius of Gyration, r, mm
1.02 ^A	0.965	14.5	21.44	4.15	2.07
1.32	1.287	14.4	21.52	5.62	2.08
1.63	1.611	14.2	21.61	7.19	2.11
2.01	2.011	14.1	21.71	9.28	2.15

^AThis thickness should only be used for the inner liner of double-wall type IA pipe, or for temporary pipe. When used for other than temporary pipe, it should be polymer coated.

Shape	Maximum Diameter or Span, ft [mm]
pipe, arch	26 [7920 mm]
pipe-arch, underpass	21 [6400 mm]

$$(EL) = Hw \quad (1)$$

5.3 This practice is not applicable for pipe with a specified thickness less than 0.052 in. [1.32 mm] for installations under railways and airport runways.

6. Loads

6.1 The design load or pressure on a pipe is comprised of earth load (EL), live load (LL), and impact load (IL). These loads are applied as a fluid pressure acting on the pipe periphery.

6.2 For steel pipe buried in a trench or in an embankment on a yielding foundation, loads are defined as follows:

6.2.1 The earth load (EL) is the weight of the column of soil directly above the pipe:

6.2.2 *Live Loads*—The live load (LL) is that portion of the weight of vehicle, train, or aircraft moving over the pipe that is distributed through the soil to the pipe.

6.2.2.1 *Live Loads Under Highway*—Live load pressures for H20 highway loadings, including impact effects, are:

Height of Cover, ft [m]	Live Load, lbf/ft ² [kPa]
1 [0.30]	1800 [86.2]
2 [0.61]	800 [38.3]
3 [0.91]	600 [28.7]
4 [1.22]	400 [19.2]
5 [1.52]	250 [12.0]
6 [1.83]	200 [9.6]
7 [2.13]	175 [8.4]
8 [2.44]	100 [4.8]
over 8 [over 2.44]	neglect [-]

TABLE 3 Sectional Properties of Corrugated Steel Sheets for Corrugation: 2 2/3 by 1/2 in. (Annular or Helical)

NOTE 1—Dimensions shown in the figure are exact values used in calculating the section properties. Nominal values, for some of these dimensions, are used in other places in this practice.

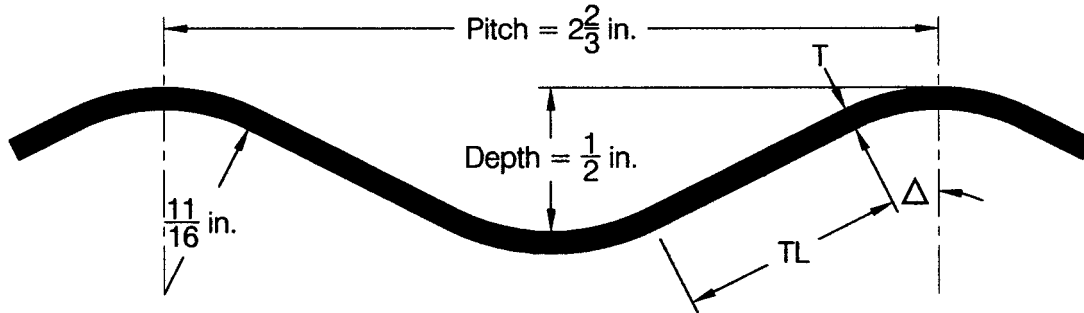

Specified Thickness, in.	Area of Section, A, in. ² /ft	Tangent Length, TL, in.	Tangent Angle, Δ, °	Moment of Inertia, I × 10 ⁻³ in. ⁴ /in.	Radius of Gyration, r, in.	Ultimate Longitudinal Seam Strength of Riveted or Spot Welded Corrugated Steel Pipe in Pounds per Foot of Seam			
						5/16-in. Rivets		3/8-in. Rivets	
						Single	Double	Single	Double
0.040 ^A	0.465	0.785	26.56	1.122	0.1702
0.052	0.619	0.778	26.65	1.500	0.1707
0.064	0.775	0.770	26.74	1.892	0.1712	16 700	21 600
0.079	0.968	0.760	26.86	2.392	0.1721	18 200	29 800
0.109	1.356	0.740	27.11	3.425	0.1741	23 400	46 800
0.138	1.744	0.720	27.37	4.533	0.1766	24 500	49 000
0.168	2.133	0.699	27.65	5.725	0.1795	25 600	51 300

^AThis thickness should only be used for the inner liner of double-wall type IA pipe, or for temporary pipe. When used for other than temporary pipe, it should be polymer coated.

TABLE 4 Sectional Properties of Corrugated Steel Sheets for Corrugation: 68 by 13 mm (Annular or Helical) [SI Units]

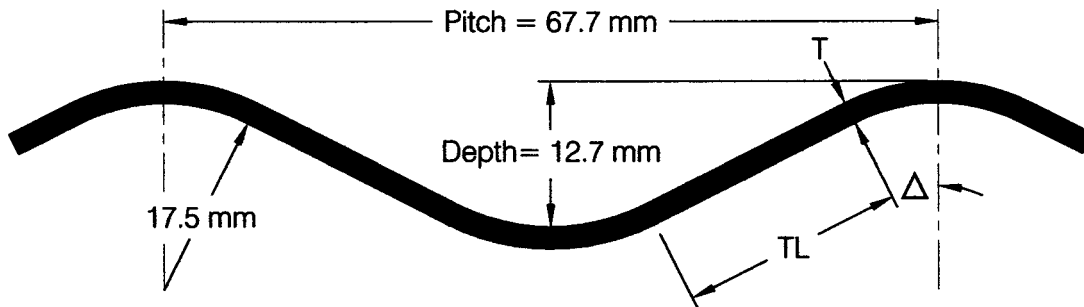

Specified Thickness, mm	Area of Section, A, mm ² /mm	Tangent Length, TL, mm	Tangent Angle, Δ, °	Moment of Inertia, I, mm ⁴ /mm	Radius of Gyration, r, mm	Ultimate Longitudinal Seam Strength of Riveted or Spot Welded Corrugated Steel Pipe in kN per m of Seam			
						8-mm Rivets		10-mm Rivets	
						Single	Double	Single	Double
1.02 ^A	0.984	19.9	26.56	18.39	4.232
1.32	1.310	19.8	26.65	24.58	4.336
1.63	1.640	19.6	26.74	31.00	4.348	244	315
2.01	2.049	19.3	26.86	39.20	4.371	266	435
2.77	2.870	18.8	27.11	56.13	4.422	341	683
3.51	3.691	18.3	27.37	74.28	4.486	357	715
4.27	4.515	17.8	27.65	93.82	4.559	374	748

^AThis thickness should only be used for the inner liner of double-wall type IA pipe, or for temporary pipe. When used for other than temporary pipe, it should be polymer coated.

TABLE 5 Sectional Properties of Corrugated Steel Sheets for Corrugation: 3 by 1 in. (Annular or Helical)

NOTE 1—Dimensions shown in the figure are exact values used in calculating the section properties. Nominal values, for some of these dimensions, are used in other places in this practice.

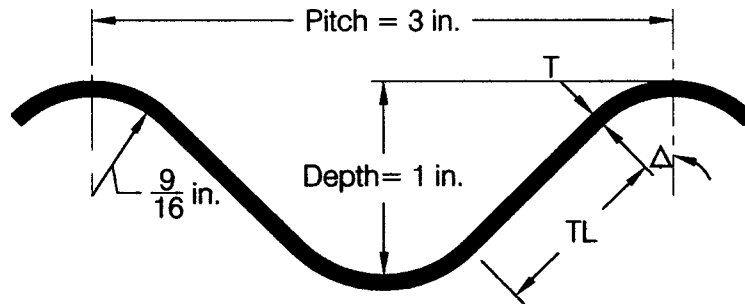

Specified Thickness, in.	Area of Section, A, in. ² /ft	Tangent Length, TL, in.	Tangent Angle, Δ, °	Moment of Inertia, I × 10 ⁻³ in. ⁴ /in.	Radius of Gyration, r, in.	Ultimate Longitudinal Seam Strength of Riveted or Spot Welded Corrugated Steel Pipe in Pounds per Foot of Seam	
						3/8-in. Rivets	7/16-in. Rivets
						Double	Double
0.052	0.711	0.951	44.39	6.892	0.3410
0.064	0.890	0.938	44.60	8.658	0.3417	28 700	...
0.079	1.113	0.922	44.87	10.883	0.3427	35 700	...
0.109	1.560	0.889	45.42	15.458	0.3448	...	53 000
0.138	2.008	0.855	46.02	20.175	0.3472	...	63 700
0.168	2.458	0.819	48.65	25.083	0.3499	...	70 700

TABLE 6 Sectional Properties of Corrugated Steel Sheets for Corrugation: 75 by 25 mm (Annular or Helical) [SI Units]

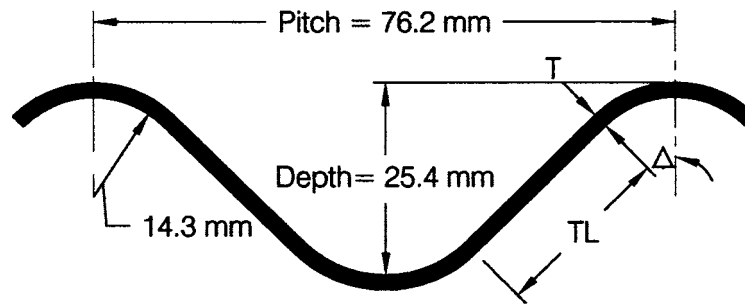

Specified Thickness, mm	Area of Section, A, mm ² /mm	Tangent Length, TL, mm	Tangent Angle, Δ, °	Moment of Inertia, I, mm ⁴ /m	Radius of Gyration, r, mm	Ultimate Longitudinal Seam Strength of Riveted or Spot Welded Corrugated Steel Pipe in kN per m of Seam	
						10-mm Rivets	11-mm Rivets
						Double	Double
1.32	1.505	24.2	44.39	112.94	8.661
1.63	1.884	23.8	44.60	141.88	8.679	419	...
2.01	2.356	23.4	44.87	178.34	8.705	521	...
2.77	3.302	22.6	45.42	253.31	8.758	...	773
3.51	4.250	21.7	46.02	330.61	8.819	...	929
4.27	5.203	20.8	46.65	411.04	8.887	...	1032

6.2.2.2 *Live Loads Under Railways*—Live load pressures for E80 railway loadings, including impact effects, are as follows:

TABLE 7 Sectional Properties of Corrugated Steel Sheets for Corrugation: 5 by 1 in. (Helical)

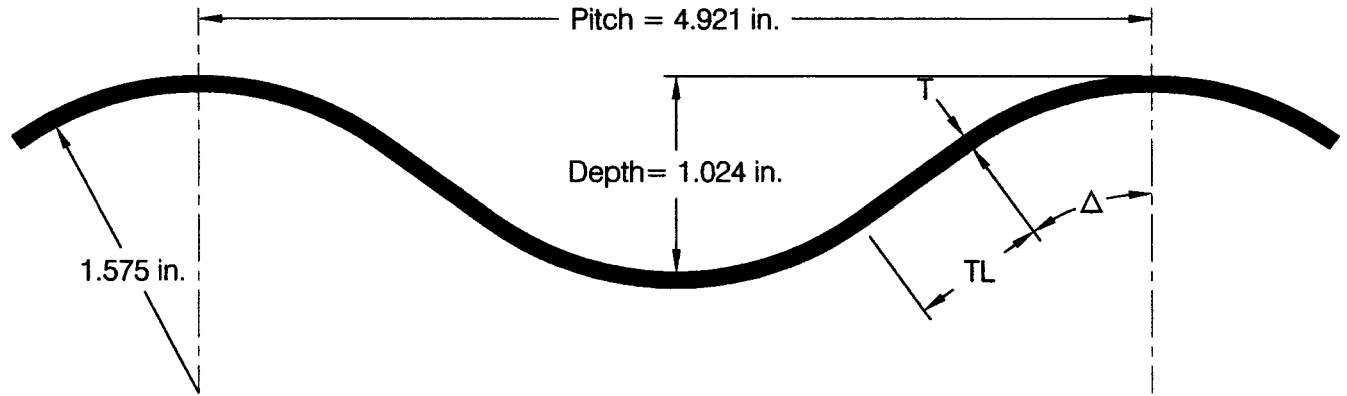

Specified Thickness, in.	Area of Section, A, in. ² /ft	Tangent Length, TL, in.	Tangent Angle, Δ, °	Moment of Inertia, I × 10 ⁻³ in. ⁴ /in.	Radius of Gyration, r, in.
0.064	0.794	0.730	35.58	8.850	0.3657
0.079	0.992	0.708	35.80	11.092	0.3663
0.109	1.390	0.664	36.30	15.550	0.3677
0.138	1.788	0.610	36.81	20.317	0.3693
0.168	2.186	0.564	37.39	25.032	0.3711

TABLE 8 Sectional Properties of Corrugated Steel Sheets for Corrugation: 125 by 25 mm (Helical) [SI Units]

NOTE 1—Dimensions shown in the figure are exact values used in calculating the section properties. Nominal values, for some of these dimensions, are used in other places in this practice.

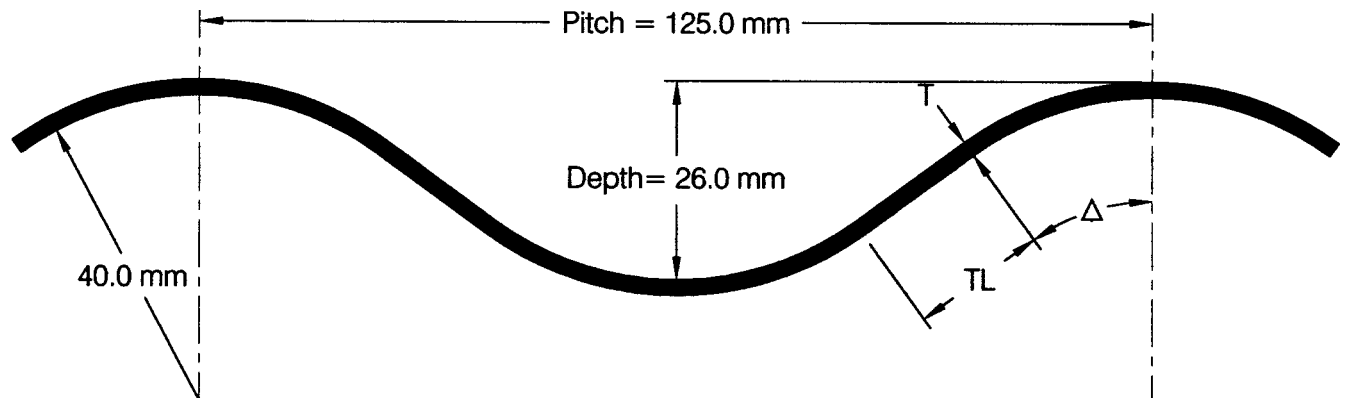

Specified Thickness, mm	Area of Section, A, mm ² /mm	Tangent Length, TL, mm	Tangent Angle, Δ, °	Moment of Inertia, I, mm ⁴ /mm	Radius of Gyration, r, mm
1.63	1.681	18.5	35.58	145.03	9.289
2.01	2.100	18.0	35.80	181.77	9.304
2.77	2.942	16.9	36.30	256.46	9.340
3.51	3.785	15.6	36.81	332.94	9.380
4.27	4.627	14.3	37.39	411.18	9.426

Height of Cover, ft [m]	Live Load, lbf/ft ² [kPa]
2 [0.61]	3800 [181.9]
5 [1.52]	2400 [114.9]
8 [2.44]	1600 [76.6]
10 [3.05]	1100 [52.7]
12 [3.66]	800 [38.3]
15 [4.57]	600 [28.7]
20 [6.10]	300 [14.4]
30 [9.14]	100 [4.8]
over 30 [over 9.14]	neglect [-]

6.2.2.3 Values for intermediate covers shall be interpolated.

6.2.2.4 *Live Loads Under Aircraft Runways*—Because of the many different wheel configurations and weights, live load pressures for aircraft vary. Such pressures must be determined for the specific aircrafts for which the installation is designed; see FAA Standard AC No. 150/5320-5B.

TABLE 9 Sectional Properties for Spiral Rib Pipe for 3/4 in. Wide by 3/4 in. Deep Rib with a Spacing of 7 1/2 in. Center to Center (Helical)

NOTE 1—Dimensions shown in the figure are exact values used in calculating the section properties. Nominal values, for some of these dimensions, are used in other places in this practice.

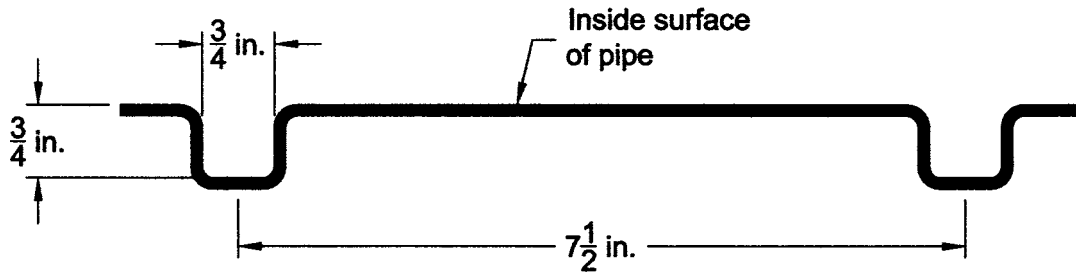

Effective Properties ^A			
Specified Thickness, in.	Area of Section, A, in. ² /ft.	Moment of Inertia, I × 10 ⁻³ in. ⁴ /in.	Radius of Gyration, r, in.
0.064	0.509	2.821	0.258
0.079	0.712	3.701	0.250
0.109	1.184	5.537	0.237
0.138	1.717	7.433	0.228

^ANet effective properties at full yield stress.

TABLE 10 Sectional Properties of Spiral Rib Pipe for 19 mm Wide by 19 mm Deep Rib with a Spacing of 190 mm Center to Center (Helical) [SI Units]

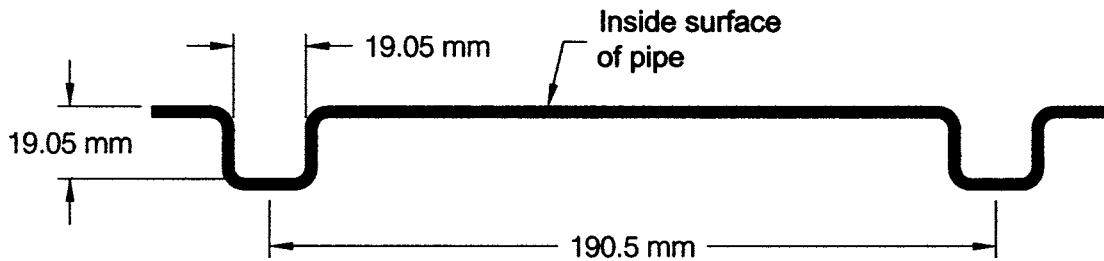

Effective Properties ^A			
Specified Thickness, mm	Area of Section, A, mm ² /mm	Moment of Inertia, I, mm ⁴ /mm	Radius of Gyration, r, mm
1.63	1.077	46.23	6.55
2.01	1.507	60.65	6.34
2.77	2.506	90.74	6.02
3.51	3.634	121.81	5.79

^ANet effective properties at full yield stress.

6.2.3 **Impact Loads**—Loads caused by the impact of moving traffic are important only at low heights of cover. Their effects have been included in the live load pressures in 6.2.2.

7. Design Method

7.1 Strength requirements for wall strength, buckling strength, and seam strength may be determined by either the allowable stress design (ASD) method presented in Section 8, or the load and resistance factor design (LRFD) method presented in Section 9. Additionally, the design considerations in other paragraphs shall be followed for either design method.

8. Design by ASD Method

8.1 The thrust in the pipe wall shall be checked by three criteria. Each considers the joint function of the steel pipe and the surrounding soil envelope.

8.1.1 Required Wall Area:

8.1.1.1 Determine the design pressure and the ring compression thrust in the steel pipe wall as follows:

$$P = EL + LL + IL \quad (2)$$

$$T = \frac{PS}{2} \quad (3)$$

8.1.1.2 Determine the required wall cross-sectional area. The safety factor (SF) on wall area is 2.

$$A = \frac{T(SF)}{f_y} \quad (4)$$

Select from Table 1, Table 3, Table 5, Table 7, Table 9, Table 11, Table 13, Table 15, Table 17, Table 19, Table 21, Table 23, Table 25, Table 27, Table 29, Table 31, or Table 33 [Table 2, Table 4, Table 6, Table 8, Table 10, Table 12, Table 14, Table

TABLE 11 Sectional Properties of Ribbed Pipe with Inserts: 3/4 in. Wide by 3/4 in. Deep Rib with a Spacing of 7 1/2 in. Center to Center (Helical)

NOTE—Dimensions shown in the figure are exact values used in calculating the section properties. Nominal values, for some of these dimensions, are used in other places in this practice.

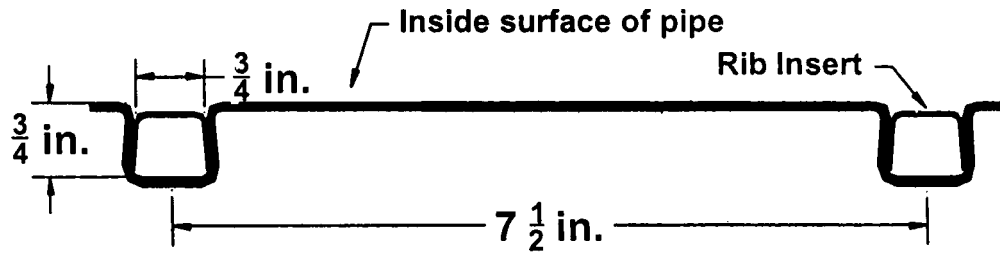

Effective Properties ^A			
Specified Thickness, in.	Area of Section, A, in. ² /ft	Moment of Inertia, I × 10 ⁻³ , in. ⁴ /in.	Radius of Gyration, r, in.
0.064	0.509	2.821	0.258
0.079	0.712	3.701	0.250
0.109	1.184	5.537	0.237
0.138	1.717	7.433	0.228

^ANet effective properties at full yield stress.

TABLE 12 Sectional Properties of Ribbed Pipe with Inserts: 19 mm Wide by 19 mm Deep Rib with a Spacing of 190 mm Center to Center (Helical) [SI Units]

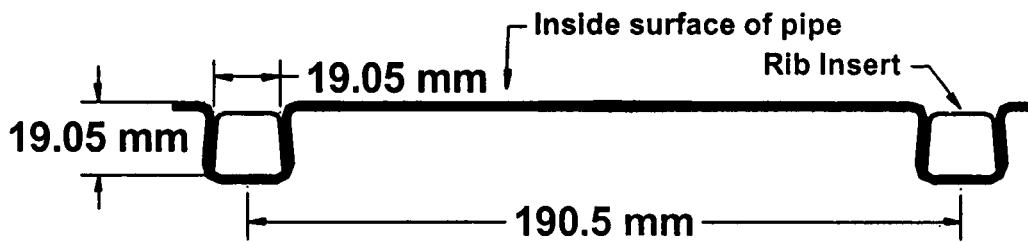

Effective Properties ^A			
Specified Thickness, mm	Area of Section, A, mm ² /mm	Moment of Inertia, I, mm ⁴ /mm	Radius of Gyration, r, mm
1.63	1.077	46.23	6.55
2.01	1.507	60.65	6.34
2.77	2.506	90.74	6.02
3.51	3.634	121.81	5.79

^ANet effective properties at full yield stress.

16, Table 18, Table 20, Table 22, Table 24, Table 26, Table 28, Table 30, Table 32, or Table 34] a wall thickness equal to or greater than the required wall area (A).

8.1.2 *Critical Buckling Stress*—Check section profile with the required wall area for possible wall buckling. If the critical buckling stress f_c is less than the minimum yield stress f_y , recalculate the required wall area using f_c instead of f_y .

$$\text{If } s < \frac{r}{k} \sqrt{\frac{24E}{f_u}} \text{ then } f_c = f_u - \frac{f_u^2}{48E} \left(\frac{ks}{r}\right)^2 \quad (5)$$

$$\text{If } s > \frac{r}{k} \sqrt{\frac{24E}{f_u}} \text{ then } f_c = \frac{12E}{\left(\frac{ks}{r}\right)^2} \quad (6)$$

8.1.3 *Required Seam Strength:*

8.1.3.1 Since helical lockseam and welded-seam pipe have no longitudinal seams, this criterion is not valid for these types of pipe.

8.1.3.2 For pipe fabricated with longitudinal seams (riveted, spot-welded, or bolted) the seam strength shall be sufficient to develop the thrust in the pipe wall. The safety factor on seam strength (SS) is 3.

$$(SS) = T (SF) \quad (7)$$

8.1.3.3 Check the ultimate seam strengths shown in Table 3, Table 5, Table 31, or Table 33, [Table 4, Table 6, Table 32, or Table 34]. If the required seam strength exceeds that shown for

TABLE 13 Sectional Properties of Spiral Rib Pipe for 3/4 in. Wide by 1 in. Deep Rib with a Spacing of 11 1/2 in. Center to Center (Helical)

NOTE 1—Dimensions shown in the figure are exact values used in calculating the section properties. Nominal values, for some of these dimensions, are used in other places in this practice.

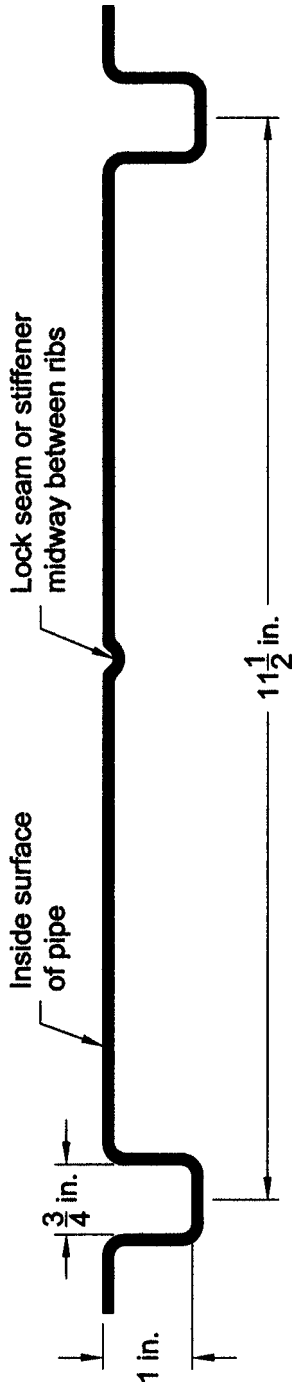

Specified Thickness, in.	Effective Properties ^A		
	Area of Section, A, in. ² /ft.	Moment of Inertia, I × 10 ⁻³ , in. ⁴ /in.	Radius of Gyration, r, in.
0.064	0.374	4.580	0.383
0.079	0.524	6.080	0.373
0.109	0.883	9.260	0.355

^ANet effective properties at full yield stress.

TABLE 14 Sectional Properties of Spiral Rib Pipe for 19 mm Wide by 25 mm Deep Rib with a Spacing of 292 mm Center to Center (Helical) [SI Units]

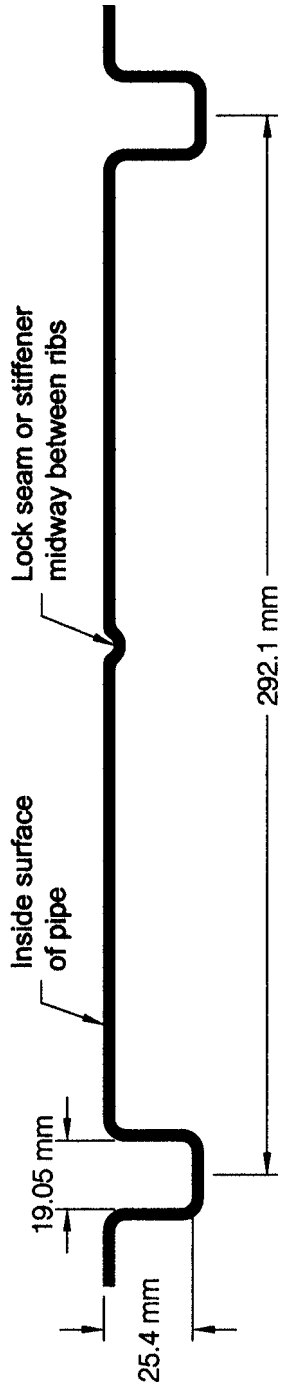

Specified Thickness, mm	Effective Properties ^A			Radius of Gyration, r, mm
	Area of Section, A, mm ² /mm	Moment of Inertia, I, mm ⁴ /mm		
1.63	0.792	75.05		9.73
2.01	1.109	99.63		9.47
2.77	1.869	151.74		9.02

^ANet effective properties at full yield stress.

TABLE 15 Sectional Properties of Spiral Rib Pipe for 3/4 in. Wide by 1 in. Deep Rib with a Spacing of 8 1/2 in. Center to Center (Helical)

NOTE 1—Dimensions shown in the figure are exact values used in calculating the section properties. Nominal values, for some of these dimensions, are used in other places in this practice.

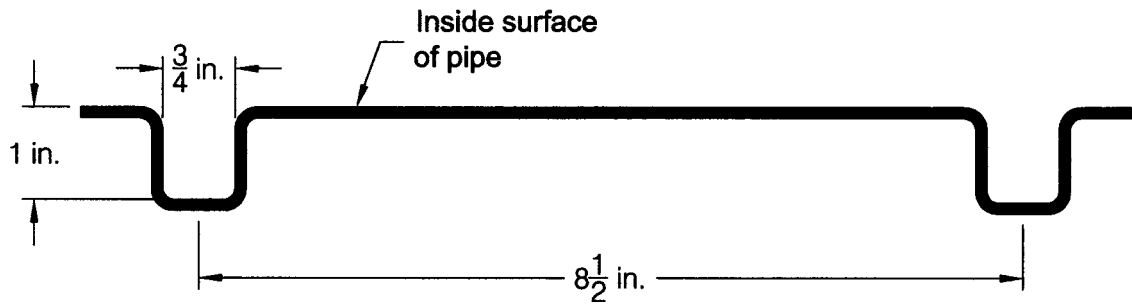

Effective Properties ^A			
Specified Thickness, in.	Area of Section, A, in. ² /ft	Moment of Inertia, I × 10 ⁻³ in. ⁴ /in.	Radius of Gyration, r, in.
0.064	0.499	5.979	0.379
0.079	0.694	7.913	0.370
0.109	1.149	11.983	0.354

^ANet effective properties at full yield stress.

TABLE 16 Sectional Properties of Spiral Rib Pipe for 19 mm Wide by 25 mm Deep Rib with a Spacing of 216 mm Center to Center (Helical) [SI Units]

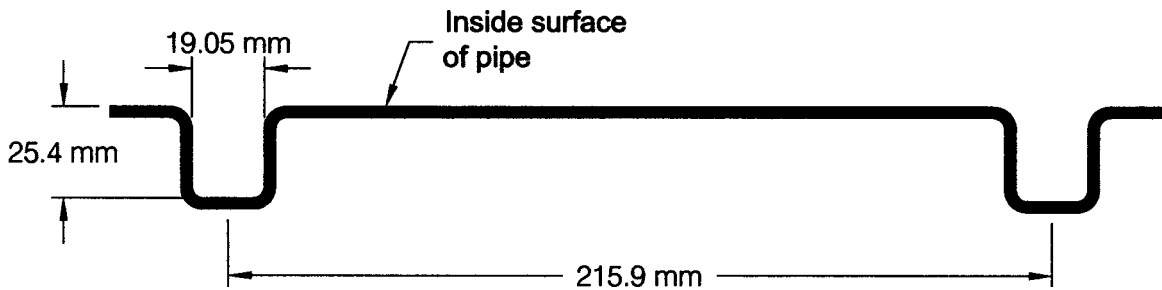

Effective Properties ^A			
Specified Thickness, mm	Area of Section, A, mm ² /mm	Moment of Inertia, I, mm ⁴ /mm	Radius of Gyration, r, mm
1.63	1.057	97.98	9.63
2.01	1.469	129.67	9.40
2.77	2.433	196.37	8.99

^ANet effective properties at full yield stress.

the steel thickness already chosen, use a heavier pipe whose seam strength exceeds the required seam strength.

9. Design by LRFD Method

9.1 *Factored Loads*—The pipe shall be designed to resist the following combination of factored earth load (EL) and live load plus impact (LL + IL):

$$P_f = 1.95 EL + 1.75 (LL + IL) \quad (8)$$

9.2 *Factored Thrust*—The factored thrust, T_f , per unit length of wall shall be determined from the factored crown pressure P_f as follows:

$$T_f = P_f S/2 \quad (9)$$

9.3 *Factored Resistance*—The factored resistance (R_f) shall equal or exceed the factored thrust. R_f shall be calculated for

the limit states of wall resistance, resistance to buckling, and seam resistance (where applicable) as follows:

$$R_f = \phi R_n \quad (10)$$

The resistance factor (ϕ) shall be as specified in Table 35. The nominal resistance (R_n) shall be calculated as specified in 9.4, 9.5, and 9.6.

9.4 *Wall Resistance*—The nominal axial resistance per unit length of wall without consideration of buckling shall be taken as:

$$R_n = f_y A \quad (11)$$

9.5 *Resistance to Buckling*—The nominal resistance calculated using Eq 11 shall be investigated for buckling. If $f_c < f_y$, R_n shall be recalculated using f_c instead of f_y . The value of f_c shall be determined from Eq 5 or Eq 6 as applicable.

TABLE 17 Sectional Properties of Composite Ribbed Steel Pipe for 3/4 in. Wide by 3/4 in. Deep Rib With a Spacing of 7 1/2 in. Center to Center (Helical)

NOTE 1—Dimensions shown in the figure are exact values used in calculating the section properties. Nominal values, for some of these dimensions, are used in other places in this practice.

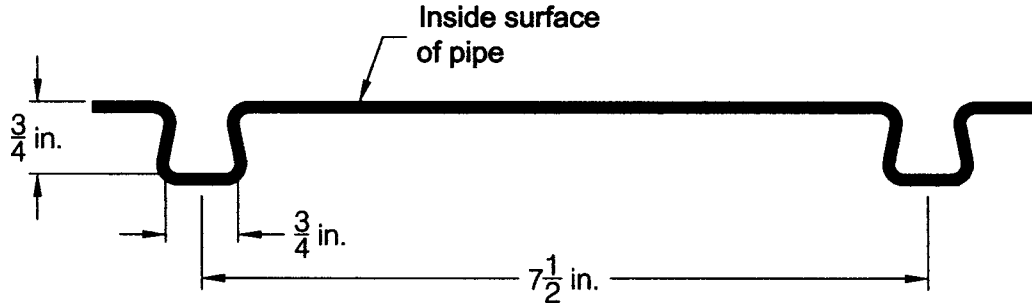

Effective Properties ^A				
Specified Thickness, in.	Area of Section, A, in. ² /ft	Moment of Inertia, I × 10 ⁻³ , in. ⁴ /in.	Radius of Gyration, r, in.	
0.064	0.520	2.768	0.253	
0.079	0.728	3.628	0.245	
0.109	1.212	5.424	0.232	
0.138	1.758	7.280	0.223	

^ANet effective properties at full yield stress.

TABLE 18 Sectional Properties of Composite Ribbed Steel Pipe for 19 mm Wide by 19 mm Deep Rib With a Spacing of 190 mm Center to Center (Helical) [SI Units]

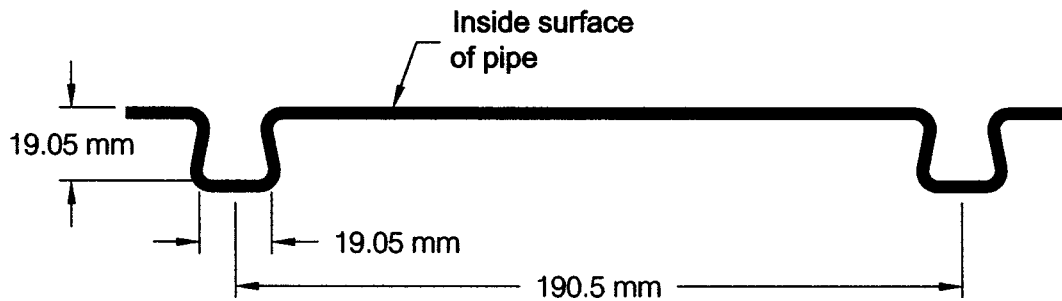

Effective Properties ^A				
Specified Thickness, mm	Area of Section, A, mm ² /mm	Moment of Inertia, I, mm ⁴ /mm	Radius of Gyration, r, mm	
1.63	1.101	45.36	6.43	
2.01	1.541	59.45	6.22	
2.77	2.565	88.88	5.89	
3.51	3.721	119.30	5.66	

^ANet effective properties at full yield stress.

9.6 *Seam Resistance*— For pipe fabricated with longitudinal seams, the nominal resistance of the seam per unit length of wall shall be taken as the ultimate seam strength shown in Table 3, Table 5, Table 31, or Table 33 [Table 4, Table 6, Table 32, or Table 34].

10. Handling and Installation

10.1 The pipe shall have enough rigidity to withstand the forces that are normally applied during shipment, handling, and installation. Both shop- and field-assembled pipe shall have

strength adequate to withstand compaction of the sidefill without interior bracing to maintain pipe shape. Handling and installation rigidity is measured by the following flexibility requirement.

$$(FF) = \frac{s^2}{EI} \quad (12)$$

10.2 For curve and tangent corrugated pipe installed in a trench cut in undisturbed soil, the flexibility factor shall not exceed the following:

TABLE 19 Sectional Properties of Composite Ribbed Steel Pipe for 3/4 in. Wide by 1 in. Deep Rib With a Spacing of 11 1/2 in. Center to Center (Helical)

NOTE 1—Dimensions shown in the figure are exact values used in calculating the section properties. Nominal values, for some of these dimensions, are used in other places in this practice.

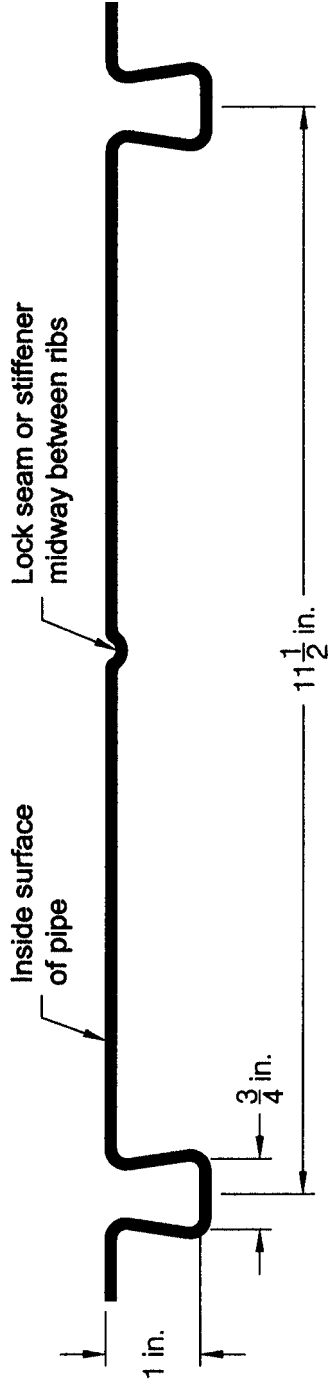

Specified Thickness, in.	Area of Section, A, in. ² /ft	Effective Properties ^A		Radius of Gyration, r, in.
		Moment of Inertia, I × 10 ⁻³ , in. ⁴ /in.		
0.064	0.371	3.753		0.348
0.079	0.521	4.949		0.338
0.109	0.878	7.472		0.320

^ANet effective properties at full yield stress.

TABLE 20 Sectional Properties of Composite Ribbed Steel Pipe for 19 mm Wide by 25 mm Deep Rib With a Spacing of 292 mm Center to Center (Helical) [SI Units]

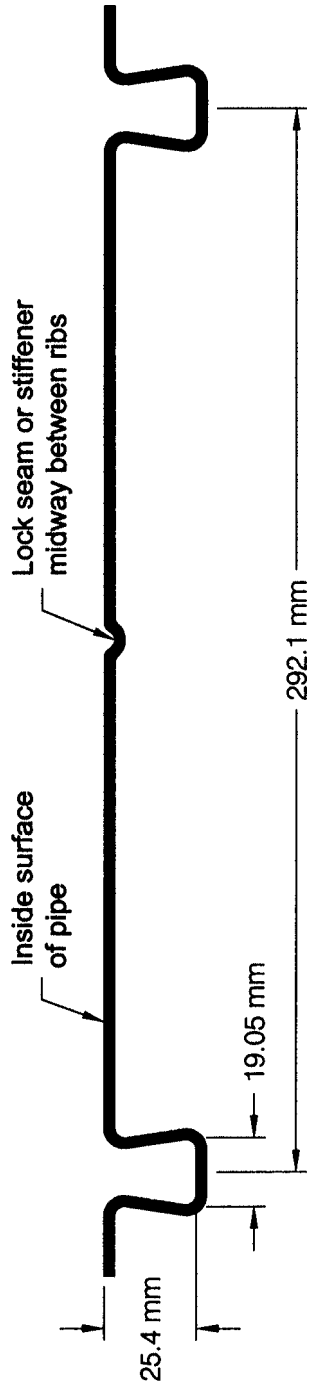

Specified Thickness, mm	Effective Properties ^A			Radius of Gyration, r, mm
	Area of Section, A, mm ² /mm	Moment of Inertia, I, mm ⁴ /mm		
1.63	0.785	61.50		8.84
2.01	1.103	81.10		8.59
2.77	1.858	122.44		8.13

^ANet effective properties at full yield stress.

TABLE 21 Sectional Properties for Closed Rib Pipe 1/2 in. Deep with Three Ribs Spaced Over 57/16 in. Center to Center (Helical)

NOTE 1—Dimensions shown in the figure are exact values used in calculating the section properties. Nominal values, for some of these dimensions, are used in other places in the standard.

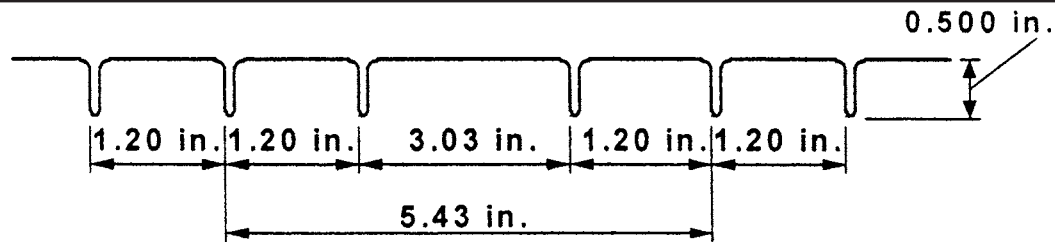

Effective Properties^A

Specified Thickness, in.	Area of Section, A, in. ² /ft	Moment of Inertia, I × 10 ⁻³ , in. ⁴ /in.	Radius of Gyration, r, in.
0.022	0.230	0.550	0.169
0.028	0.341	0.778	0.166

^ANet effective properties at full yield stress.

TABLE 22 Sectional Properties for Closed Rib Pipe 13 mm Deep with Three Ribs Spaced Over 138 mm Center to Center (Helical)

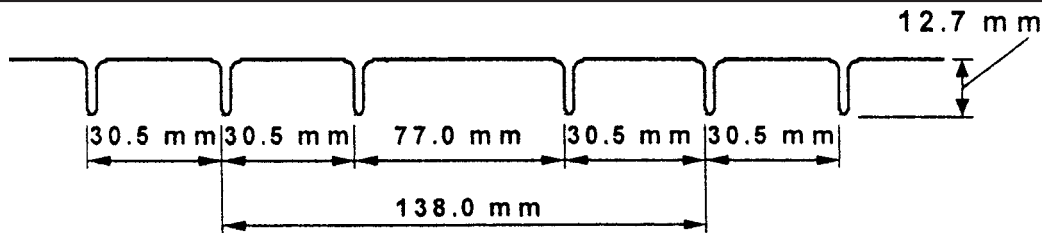

Effective Properties^A

Specified Thickness, mm	Area of Section, A, mm ² /mm	Moment of Inertia, I, mm ⁴ /mm	Radius of Gyration, r, mm
0.56	0.487	9.01	4.29
0.71	0.722	12.75	4.22

^ANet effective properties at full yield stress.

TABLE 23 Sectional Properties for Closed Rib Pipe 3/8 in. Deep with Three Ribs Spaced Over 57/16 in. Center to Center (Helical)

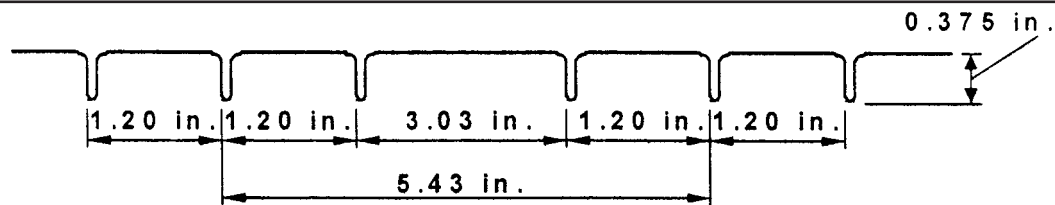

Effective Properties^A

Specified Thickness, in.	Area of Section, A, in. ² /ft	Moment of Inertia, I × 10 ⁻³ , in. ⁴ /in.	Radius of Gyration, r, in.
0.022	0.200	0.261	0.125
0.028	0.301	0.366	0.121

^ANet effective properties at full yield stress.

Depth of Corrugation, in. [mm]	FF, in./lbf [mm/N]	Depth of Corrugation, in. [mm]	FF, in./lbf [mm/N]
1/4 [6.5]	0.060 [0.342]	1/4 [6.5]	0.043 [0.245]
3/8 [10]	0.060 [0.342]	3/8 [10]	0.043 [0.245]
1/2 [13]	0.060 [0.342]	1/2 [13]	0.043 [0.245]
1 [25]	0.060 [0.342]	1 [25]	0.033 [0.188]
2 [51]	0.020 [0.114]	2 (round pipe) [51]	0.020 [0.114]
5/2 [140]	0.020 [0.114]	2 (pipe-arch, arch, underpass) [51]	0.030 [0.171]
		5/2 (round pipe) [140]	0.020 [0.114]
		5/2 (pipe-arch, arch, underpass) [140]	0.030 [0.171]

10.3 For curve and tangent corrugated pipe installed in an embankment or fill section and for all multiple lines of pipe, the flexibility factor shall not exceed the following:

TABLE 24 Sectional Properties for Closed Rib Pipe 9.5 mm Deep with Three Ribs Spaced Over 138 mm Center to Center (Helical)

NOTE 1—Dimensions shown in the figure are exact values used in calculating the section properties. Nominal values, for some of these dimensions, are used in other places in the standard.

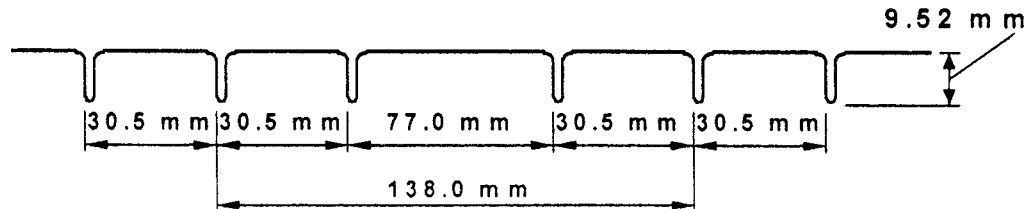

Specified Thickness, mm	Area of Section, A, mm ² /mm	Moment of Inertia, I, mm ⁴ /mm	Radius of Gyration, r, mm
0.56	0.423	4.28	3.18
0.71	0.637	6.00	3.07

TABLE 25 Sectional Properties for Closed Rib Pipe ¼ in. Deep with Three Ribs Spaced Over 5⁷/₁₆ in. Center to Center (Helical)

NOTE 1—Dimensions shown in the figure are exact values used in calculating the section properties. Nominal values, for some of these dimensions, are used in other places in the standard.

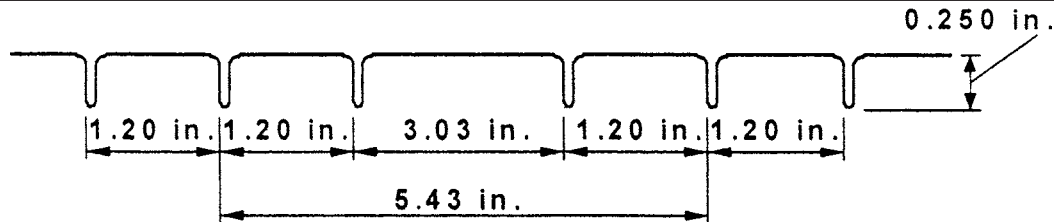

Effective Properties^A

Specified Thickness, in.	Area of Section, A, in. ² /ft	Moment of Inertia, I × 10 ⁻³ in. ⁴ /in.	Radius of Gyration, r, in.
0.022	0.170	0.0912	0.0801
0.028	0.261	0.1266	0.0764

^ANet effective properties at full yield stress.

TABLE 26 Sectional Properties for Closed Rib Pipe 6 mm Deep with Three Ribs Spaced Over 138 mm Center to Center (Helical)

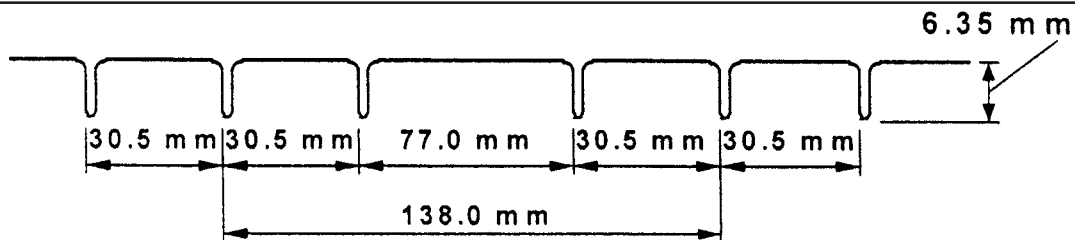

Effective Properties^A

Specified Thickness, mm	Area of Section, A, mm ² /mm	Moment of Inertia, I, mm ⁴ /mm	Radius of Gyration, r, mm
0.56	0.360	1.49	2.03
0.71	0.552	2.07	1.94

^ANet effective properties at full yield stress.

10.4 For ribbed pipes and ribbed pipes with metallic-coated inserts, installed in a trench cut in undisturbed soil and provided with a soil envelope meeting the requirements of 18.2.3 to minimize compactive effort, the flexibility factor shall not exceed the following:

Profile, in. [mm]	FF, in./lbf [mm/N]
¾ by ¾ by 7½ [19 by 19 by 190]	0.367 ^{1/3} [0.0825]
¾ by 1 by 8½ [19 by 25 by 216]	0.262 ^{1/3} [0.0589]
¾ by 1 by 11½ [19 by 25 by 292]	0.220 ^{1/3} [0.0495]

10.5 For ribbed pipes and ribbed pipes with metallic-coated inserts, installed in a trench cut in undisturbed soil and where the soil envelope does not meet the requirements of 18.2.3, the flexibility factor shall not exceed the following:

Profile, in. [mm]	FF, in./lbf [mm/N]
¾ by ¾ by 7½ [19 by 19 by 190]	0.263 ^{1/3} [0.0591]
¾ by 1 by 8½ [19 by 25 by 216]	0.163 ^{1/3} [0.0366]
¾ by 1 by 11½ [19 by 25 by 292]	0.163 ^{1/3} [0.0366]

TABLE 27 Sectional Properties for Composite Corrugated Pipe with ½ by ¼ in. Corrugations (Helical)

NOTE 1—Dimensions shown in the figure are exact values used in calculating the section properties. Nominal values, for some of these dimensions, are used in other places in this practice.

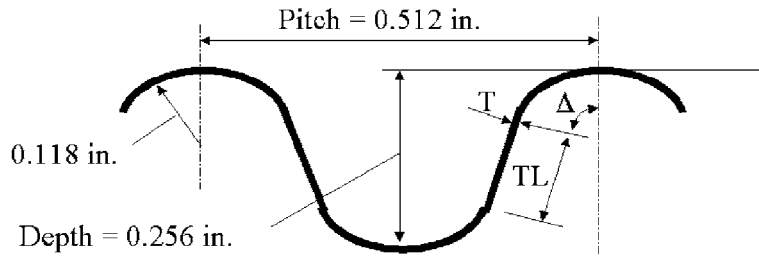

Specified Thickness, in.	Area of Section, A, in. ² /in.	Moment of Inertia, I, $I \times 10^{-3}$ in. ⁴ /in.	Radius of Gyration, r, in.
0.009	0.175	0.099	0.0825
0.012	0.236	0.133	0.0822

TABLE 28 Sectional Properties for Composite Corrugated Pipe with 13 by 6.5 mm Corrugations (Helical) [SI Units]

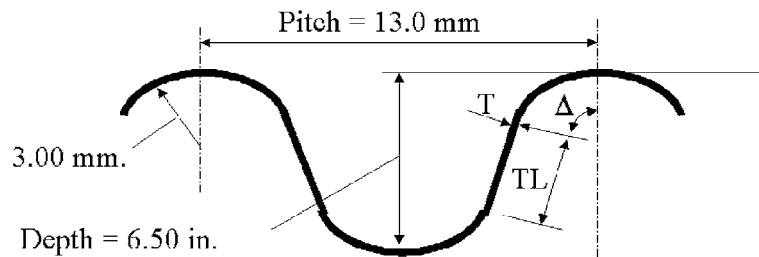

Specified Thickness, mm	Area of Section, A, mm ² /mm	Moment of Inertia, I, $I \times 10^{-3}$ mm ⁴ /mm	Radius of Gyration, r, mm
0.23	0.370	0.162	2.096
0.30	0.500	2.180	2.088

TABLE 29 Sectional Properties for Composite Corrugated Pipe with ⅞ by ⅜ in. Corrugations (Helical)

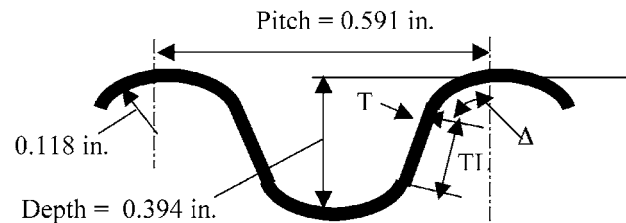

Specified Thickness, in.	Area of Section, A, in. ² /ft	Tangent Length, TL, in.	Tangent Angle, Δ, °	Moment of Inertia, I, $I \times 10^{-3}$ in. ⁴ /in.	Radius of Gyration, r, in.
0.009	0.200	0.222	74.55	0.256	0.1238
0.012	0.269	0.217	75.13	0.342	0.1236

10.6 For ribbed pipes and ribbed pipes with metallic-coated inserts, installed in an embankment or fill section, the flexibility factor shall not exceed the following:

TABLE 30 Sectional Properties for Composite Corrugated Pipe with 15 by 10 mm Corrugations (Helical) [SI Units]

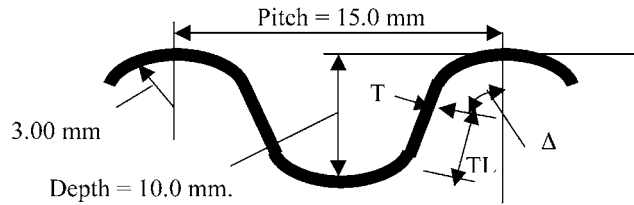

Specified Thickness, mm	Area of Section, A, mm ² /mm	Tangent Length, TL, mm	Tangent Angle, Δ, °	Moment of Inertia, I, mm ⁴ /mm	Radius of Gyration, r, mm
0.23	0.423	5.64	74.55	4.195	3.144
0.30	0.569	5.50	75.13	5.604	3.139

TABLE 31 Sectional Properties of Corrugated Steel Plates for Corrugation: 6 by 2 in. (Annular)

NOTE 1—Dimensions shown in the figure are exact values used in calculating the section properties. Nominal values, for some of these dimensions, are used in other places in this practice.

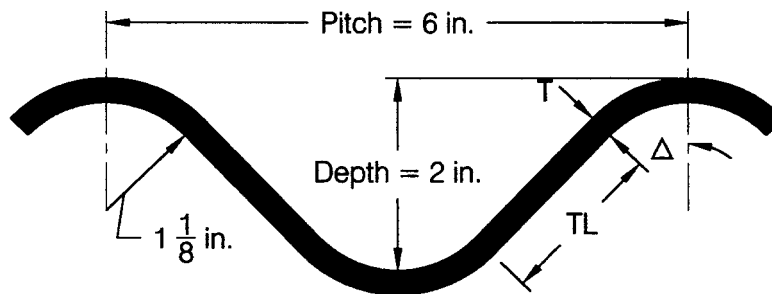

Specified Thickness, in.	Area of Section, A, in. ² /ft	Tangent Length, TL, in.	Tangent Angle, Δ, °	Moment of Inertia, I × 10 ⁻³ , in. ⁴ /in.	Radius of Gyration, r, in.	Ultimate Strength of Bolted Structural Plate Longitudinal Seams in Pounds per Foot of Seam		
						2 Bolts per Corrugation ^{A,B}	3 Bolts per Corrugation ^{A,B}	4 Bolts per Corrugation ^{A,B}
0.111	1.556	1.893	44.47	60.417	0.682	42 000
0.140	2.003	1.861	44.73	78.167	0.684	62 000
0.170	2.449	1.828	45.00	96.167	0.686	81 000
0.188	2.739	1.807	45.18	108.000	0.688	93 000
0.218	3.199	1.773	45.47	126.917	0.690	112 000
0.249	3.658	1.738	45.77	146.167	0.692	132 000
0.280	4.119	1.702	46.09	165.834	0.695	144 000	180 000	194 000
0.318	4.671	1.653	46.47	190.000	0.698	235 000
0.380	5.613	1.581	47.17	232.000	0.704	285 000

^ABolts are 3/4-in. diameter for 0.280-in. or thinner materials. Thicker materials require 7/8-in. bolts.

^BThe number of bolts per corrugation includes the bolts in the corrugation crest and in the corrugation valley; the number of bolts within one pitch.

Profile, in. [mm]	FF, in./lbf [mm/N]
3/4 by 3/4 by 7 1/2 [19 by 19 by 190]	0.217 I ^{1/3} [0.0488]
3/4 by 1 by 8 1/2 [19 by 25 by 216]	0.140 I ^{1/3} [0.0315]
3/4 by 1 by 11 1/2 [19 by 25 by 292]	0.140 I ^{1/3} [0.0315]

10.7 For composite ribbed pipe, the flexibility factor limits for ribbed pipe in 10.4-10.6 shall be multiplied by 1.05.

10.8 For closed rib pipe installed in a trench cut in undisturbed soil, or in an embankment or fill section, and for all multiple lines of such pipe, the flexibility factor shall not exceed the following:

Depth of Rib, in. [mm]	FF, in./lbf [mm/N]
1/2 [13]	0.0575 [0.328]
3/8 [9.5]	0.0500 [0.286]
1/4 [6]	0.0500 [0.286]

11. Minimum Cover Requirements

11.1 *Minimum Cover Design*—Where pipe is to be placed under roads, streets, or freeways, the minimum cover requirements shall be determined. Minimum cover (H_{min}) is defined as the distance from the top of the pipe to the top of rigid pavement or to the top of subgrade for flexible pavement. Maximum axle loads in accordance with AASHTO “Standard Specification for Highway Bridges” are as follows:

Class of Loading	Maximum Axle Load, lbf [N]
H20	32 000 [142 300]
HS 20	32 000 [142 300]
H15	24 000 [106 700]
HS 15	24 000 [106 700]

TABLE 32 Sectional Properties of Corrugated Steel Plates for Corrugation: 152 by 51 mm (Annular) [SI Units]

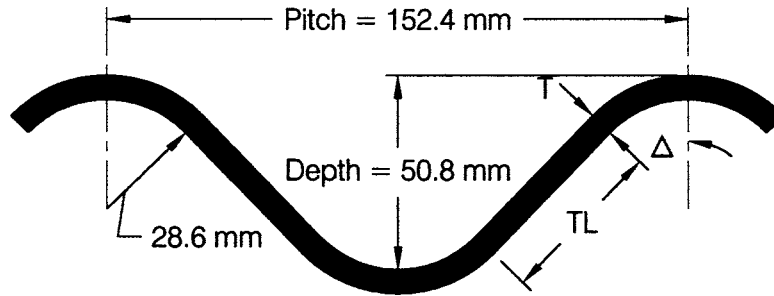

Specified Thickness, mm	Area of Section, A, mm ² /mm	Tangent Length, TL, mm	Tangent Angle, Δ, °	Moment of Inertia, mm ⁴ /mm	Radius of Gyration, r, mm	Ultimate Strength of Bolted Structural Plate Longitudinal Seams in kN per m of Seam		
						2 Bolts per Corrugation ^{A,B}	3 Bolts per Corrugation ^{A,B}	4 Bolts per Corrugation ^{A,B}
2.82	3.294	48.08	44.47	990.06	17.3	613
3.56	4.240	47.27	44.73	1280.93	17.4	905
4.32	5.184	46.43	45.00	1575.89	17.4	1182
4.79	5.798	45.90	45.18	1769.80	17.5	1357
5.54	6.771	45.03	45.47	2079.80	17.5	1634
6.32	7.743	44.15	45.77	2395.25	17.6	1926
7.11	8.719	43.23	46.09	2717.53	17.7	2101	2626	2830
8.08	9.887	41.99	46.47	3113.54	17.7	3430
9.65	11.881	40.16	47.17	3801.80	17.9	4159

^ABolts are M20 for 7.11 mm or thinner materials. Thicker materials require M22 bolts.

^BThe number of bolts per corrugation includes the bolts in the corrugation crest and in the corrugation valley; the number of bolts within one pitch.

TABLE 33 Sectional Properties of Corrugated Steel Plates for Corrugation: 15 by 5½ in. (Annular)

NOTE 1—Dimensions shown in the figure are exact values used in calculating the section properties. Nominal values, for some of these dimensions, are used in other places in this practice.

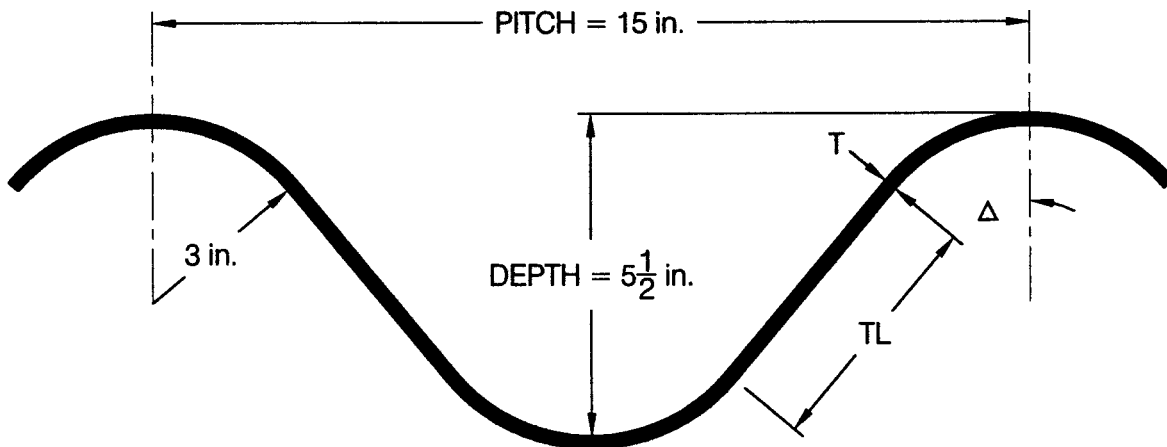

Specified Thickness, in.	Area of Section, A, in. ² /ft	Tangent Length, TL, in.	Tangent Angle, Δ, °	Moment of Inertia, I × 10 ⁻³ in. ⁴ /in.	Radius of Gyration, r, in.	Ultimate Strength of Bolted Structural Plate Longitudinal Seams in Pounds per Foot of Seam	Bolt Diameter, in.
						6 Bolts per Corrugation ^A	
0.140	2.260	4.361	49.75	714.63	1.948	66 000	¾
0.170	2.762	4.323	49.89	874.62	1.949	87 000	¾
0.188	3.088	4.299	49.99	978.64	1.950	102 000	¾
0.218	3.604	4.259	50.13	1143.59	1.952	127 000	¾
0.249	4.118	4.220	50.28	1308.42	1.943	144 000	¾
0.280	4.633	4.179	50.43	1472.17	1.954	144 000	¾
0.249	4.118	4.220	50.28	1308.42	1.943	159 000	7/8
0.280	4.633	4.179	50.43	1472.17	1.954	177 000	7/8

^AThe number of bolts per corrugation includes the bolts in the corrugation crest and in the corrugation valley; the number of bolts within one pitch.

When:

TABLE 34 Sectional Properties of Corrugated Steel Plates for Corrugation: 381 by 140 mm (Annular) [SI Units]

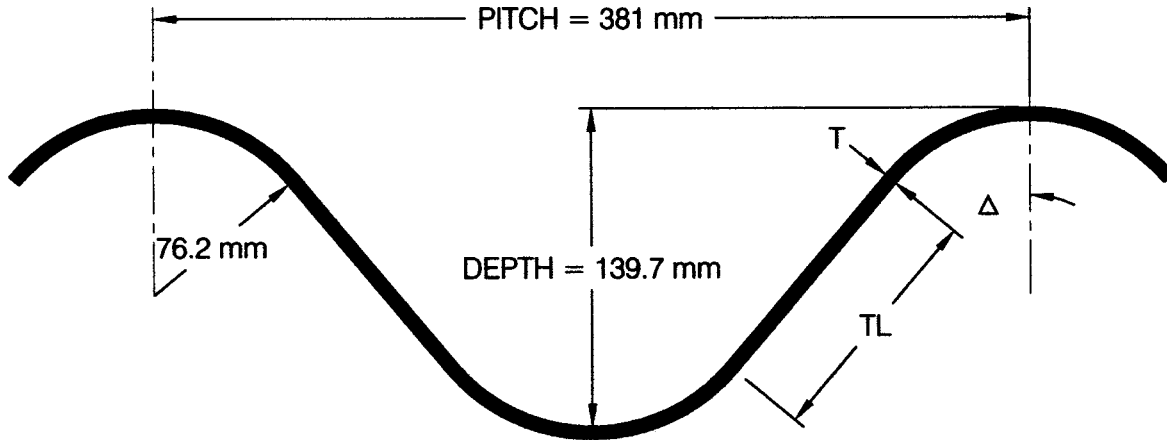

Specified Thickness, mm	Area of Section, A, mm ² /mm	Tangent Length, TL, mm	Tangent Angle, Δ, °	Moment of Inertia, I, mm ⁴ /mm	Radius of Gyration, r, mm	Ultimate Strength of Bolted Structural Plate	Bolt Diameter, mm
						Longitudinal Seams in kN per m of Seam 6 Bolts per Corrugation ^A	
3.56	4.784	110.8	49.75	11710.7	49.48	963	19
4.32	5.846	109.8	49.89	14332.5	49.50	1270	19
4.79	6.536	109.2	49.99	16037.0	49.53	1489	19
5.54	7.628	108.2	50.13	18740.1	49.58	1853	19
6.32	8.716	107.2	50.28	21441.2	49.61	2101	19
7.11	9.807	106.1	50.43	24124.5	49.63	2101	19
6.32	8.716	107.2	50.28	21441.2	49.61	2320	22
7.11	9.807	106.1	50.43	24124.5	49.63	2583	22

^AThe number of bolts per corrugation includes the bolts in the corrugation crest and in the corrugation valley; the number of bolts within one pitch.

TABLE 35 Resistance Factors for LRFD Design

Type of Pipe	Limit State	Resistance Factor, φ
Helical pipe with lock seam or fully welded seam	Minimum wall area and buckling	1.00
Annular pipe with spot-welded, riveted, or bolted seam	Minimum wall area and buckling	1.00
	Minimum seam strength	0.67
Structural plate pipe	Minimum wall area and buckling	1.00
	Minimum seam strength	0.67

$$\sqrt{\frac{(AL)d}{EI}} > 0.23 \text{ or } < 0.45, \quad (13)$$

the minimum cover requirement is:

$$H_{\min} = 0.55S \sqrt{\frac{(AL)d}{EI}} \quad (14)$$

When:

$$\sqrt{\frac{(AL)d}{EI}} < 0.23 \text{ then } H_{\min} = \frac{S}{8} \quad (15)$$

When:

$$\sqrt{\frac{(AL)d}{EI}} > 0.45 \text{ then } H_{\min} = \frac{S}{4} \quad (16)$$

In all cases, H_{\min} is never less than 1 ft [300 mm]. Additionally, for pipe with a specified thickness less than 0.052 in. [1.32 mm], H_{\min} shall not be less than 2 ft [600 mm].

11.2 Minimum Cover Under Railways—Where pipe is to be placed under railways, the minimum cover (measured from the top of the pipe to the bottom of the cross-ties) shall not be less than 1/4 of the span for factory-made pipe, or 1/5 of the span for

field-bolted pipe. In all cases, the minimum cover is never less than 1 ft [300 mm] for round pipe, or 2 ft [600 mm] for arches and pipe-arches.

11.3 Minimum Cover Under Aircraft Runways—Where pipe is to be placed under rigid-pavement runways, the minimum cover is 1.5 ft [450 mm] from the top of the pipe to the bottom of the slab, regardless of the type of pipe or the loading. For pipe under flexible-pavement runways, the minimum cover must be determined for the specific pipe and loadings that are to be considered; see FAA Standard AC No. 150/5320-5B.

11.4 Construction Loads—It is important to protect drainage structures during construction. Heavy construction equipment shall not be allowed close to or on buried pipe unless provisions are made to accommodate the loads imposed by such equipment. The minimum cover shall be 4 ft [1.2 m] unless field conditions and experience justify modification.

12. Deflection

12.1 The application of deflection design criteria is optional. Long-term field experience and test results have demonstrated

that corrugated steel pipe, properly installed using suitable fill material, will experience no significant deflection. Some designers, however, continue to apply a deflection limit.

13. Smooth-Lined Pipe

13.1 Corrugated steel pipe composed of a smooth interior steel liner and a corrugated steel exterior shell that are attached integrally at the continuous helical lockseam shall be designed in accordance with this practice on the same basis as a standard corrugated steel pipe having the same corrugation as the shell and a weight per unit length equal to the sum of the weights of liner and shell. The corrugated shell shall be limited to corrugations having a maximum pitch of 3 in. [75 mm] nominal and a thickness of not less than 60 % of the total thickness of the equivalent standard pipe. The distance between parallel helical seams, when measured along the longitudinal axis of the pipe, shall be no greater than 30 in. [750 mm].

14. Smooth Pipe with Ribs

14.1 Pipe composed of a single thickness of smooth sheet, or smooth sheet and composite polyethylene liner, with helical rectangular or deltoid ribs projecting outwardly, shall be designed on the same basis as a standard corrugated steel pipe.

14.2 Pipe composed of a single thickness of smooth sheet with helical closed ribs projecting outwardly shall be designed on the same basis as a standard corrugated pipe.

14.3 Pipe composed of a single thickness of smooth sheet with essentially rectangular helical ribs projecting outwardly and having metallic-coated inserts, shall be designed on the same basis as a standard corrugated steel pipe.

15. Composite Corrugated Steel Pipe

15.1 Composite corrugated steel pipe of all types shall be designed on the same basis as standard corrugated steel pipe with a curve and tangent profile.

16. Pipe-Arch Design

16.1 Pipe-arch and underpass design shall be similar to round pipe using twice the top radius as the span (S).

17. Materials

17.1 Acceptable pipe materials, methods of manufacture, and quality of finished pipe are given in Specifications **A 760/A 760M**, **A 761/A 761M**, **A 762/A 762M**, **A 978/A 978M**, **A 1019/A 1019M**, and **A 1042/A 1042M**.

18. Soil Design

18.1 The performance of a flexible corrugated steel pipe is dependent on soil-structure interaction and soil stiffness.

18.2 *Soil Parameters to be Considered:*

18.2.1 The type and anticipated behavior of the foundation soil under the design load must be considered.

18.2.2 The type compacted density and strength properties of the soil envelope immediately adjacent to the pipe shall be established. Good side-fill material is considered to be a granular material with little or no plasticity and free of organic material. Soils meeting the requirements of Groups GW, GP, GM, GC, SW, and SP as described in Classification **D 2487** are

acceptable, when compacted to 90 % of maximum density as determined by Test Method **D 698**. Test Method **D 1556**, **D 2167**, **D 2922**, or **D 2937** are alternate methods used to determine the in-place density of the soil. Soil types SM and SC are acceptable but require closer control to obtain the specified density; the recommendation of a qualified geotechnical or soils engineer is advisable, particularly on large structures.

18.2.3 Ribbed pipes, ribbed pipes with metallic-coated inserts, and composite ribbed pipes covered by **10.4** shall have soil envelopes of clean, nonplastic materials meeting the requirements of Groups GP and SP in accordance with Classification **D 2487**, or well-graded granular materials meeting the requirements of Groups GW, SW, GM, SM, GC, or SC in accordance with Classification **D 2487**, with a maximum plasticity index (PI) of 10. All envelope materials shall be compacted to a minimum 90 % standard density in accordance with Test Method **D 698**. Maximum loose lift thickness shall be 8 in. [200 mm].

NOTE 1—Soil cement or cement slurries are acceptable alternatives to select granular materials

18.2.4 Closed rib pipes covered by **10.8** shall meet the requirements of **18.2.2** but, when the height of cover is over 15 ft [4.6 m], the structural soil envelope shall be compacted to 95 % of maximum density.

18.2.5 The size of the structural soil envelope shall be 2 ft [600 mm] minimum each side for trench installations and one diameter minimum each side for embankment installations. This structural soil envelope shall extend at least 1 ft [300 mm] above the top of the pipe.

18.3 *Pipe-Arch Soil Bearing Design*—The pipe-arch shape causes the soil pressure at the corner to be much higher than the soil pressure across the top of the pipe-arch. The maximum height of cover and the minimum cover requirement are often determined by the bearing capacity of the soil in the region of the pipe-arch corner. Accordingly, bedding and backfill material in the region of the pipe-arch corners shall be selected and placed such that the allowable soil bearing pressure is no less than the anticipated corner pressure calculated from the following equation:

$$P_c = (C_1LL + EL)r_1/r_c \quad (17)$$

LL shall be calculated as described in Section **6** for the design depths of fill (maximum and minimum), except that the following modifications shall be made to remove impact effects: (1) for H20 live loads (see **6.2.2.1**) use 1600 psf [77 kPa] instead of 1800 psf [86 kPa]; and (2) for E80 live loads, divide the live load pressures listed in **6.2.2.2** by 1.5. The factor C_1 may be conservatively taken as 1.0 or may be calculated as follows:

18.3.1 For H20 highway live loads:

$$C_1 = L_1/L_2 \text{ when } L_2 \leq 72 \text{ in. [1830 mm]} \quad (18)$$

$$C_1 = 2L_1/L_3 \text{ when } L_2 > 72 \text{ in. [1830 mm]}$$

where:

$$L_1 = 40 + (h - 12)1.75 \quad [L_1 = 1016 + (h - 305)1.75] \quad (19)$$

$$L_2 = L_1 + 1.37s \quad [L_2 = L_1 + 1.37s]$$

$$L_3 = L_2 + 72 \quad [L_3 = L_2 + 1829]$$

18.3.2 For E80 railway live loads:

$$C_1 = L_1/L_2 \quad (20)$$

where:

$$L_1 = 96 + 1.75h \quad [L_1 = 2438 + 1.75h] \quad (21)$$

$$L_2 = L_1 + 1.37s \quad [L_2 = L_1 + 1.37s]$$

19. Minimum Spacing

19.1 When multiple lines of pipes or pipe-arches greater than 48 in. [1200 mm] in diameter or span are used, they shall be spaced so that the sides of the pipe shall be no closer than one half of a diameter or 3 ft [900 mm], whichever is less, so that sufficient space for adequate compaction of the fill material is available. For diameters up to 48 in. [1200 mm], the minimum distance between the sides of the pipes shall be no less than 2 ft [600 mm].

19.2 Materials, such as cement slurry, soil cement, concrete, and various foamed mixes, that set-up without mechanical compaction are permitted to be placed between structures with as little as 6 in. [150 mm] of clearance.

20. End Treatment

20.1 Protection of end slopes shall require special consideration where backwater conditions occur or where erosion and uplift could be a problem.

20.2 End walls designed on a skewed alignment require special design.

21. Abrasive or Corrosive Conditions

21.1 Where additional resistance to corrosion is required, consider increasing the steel thickness or the use of coatings. Where additional resistance to abrasion is required, consider the use of invert paving as well.

22. Construction and Installation

22.1 The construction and installation of corrugated steel pipe and pipe-arches and steel structural plate pipe, pipe-arches, arches, and underpasses shall conform to Practice **A 798/A 798M** or **A 807/A 807M**.

23. Structural Plate Arches

23.1 The design of structural plate arches shall be based on a minimum ratio of rise to span of 0.3; otherwise, the structural design is the same as for structural plate pipe.

23.2 Footing Design:

23.2.1 The load transmitted to the footing is considered to act tangential to the steel plate at its point of connection to the footing. The load is equal to the thrust in the arch plate.

23.2.2 The footing shall be designed to provide settlement of an acceptable magnitude uniformly along the longitudinal axis. Providing for the arch to settle will protect it from possible overload forces induced by the settling adjacent embankment fill.

23.2.3 Where poor materials that do not provide adequate support are encountered, a sufficient quantity of the poor material shall be removed and replaced with acceptable material.

23.2.4 It is undesirable to make the arch relatively unyielding or fixed compared to the adjacent sidefill. The use of massive footings or piles to prevent settlement of the arch is generally not required.

23.2.5 Invert slabs or other appropriate methods should be provided when scour is anticipated.

24. Keywords

24.1 abrasive conditions; buried applications; composite structure; corrosive conditions; corrugated steel pipe; dead loads; embankment installation; handling and installation; live loads; minimum cover; sectional properties; sewers; steel pipe structural design; trench installation

SUMMARY OF CHANGES

Committee A05 has identified the location of selected changes to this standard since the last issue, A 796/A 796M-04a, that may impact the use of this standard. (May 1, 2006)

(1) Added “ribbed pipe with metallic-coated inserts” to the standard.

(2) Added **Table 11** and **Table 12**.

ASTM International takes no position respecting the validity of any patent rights asserted in connection with any item mentioned in this standard. Users of this standard are expressly advised that determination of the validity of any such patent rights, and the risk of infringement of such rights, are entirely their own responsibility.

This standard is subject to revision at any time by the responsible technical committee and must be reviewed every five years and if not revised, either reapproved or withdrawn. Your comments are invited either for revision of this standard or for additional standards and should be addressed to ASTM International Headquarters. Your comments will receive careful consideration at a meeting of the responsible technical committee, which you may attend. If you feel that your comments have not received a fair hearing you should make your views known to the ASTM Committee on Standards, at the address shown below.

This standard is copyrighted by ASTM International, 100 Barr Harbor Drive, PO Box C700, West Conshohocken, PA 19428-2959, United States. Individual reprints (single or multiple copies) of this standard may be obtained by contacting ASTM at the above address or at 610-832-9585 (phone), 610-832-9555 (fax), or service@astm.org (e-mail); or through the ASTM website (www.astm.org).